



ACTUATOR TYPE:
OPEN - CLOSE / THREE POSITION
GEB141.1E
TG056-0



OVERVIEW

Control function:	Open - close / Three position
Nominal torque:	20Nm
Voltage:	AC 24V, DC 24V - 48V
Auxiliary switches:	None

- For use in damper areas up to 4m² - friction dependent
- Self-centering shaft adapter
- Mechanically adjustable span between 0° - 90°
- Prewired with 0.9m long connection cable
- Position indicator

CABLE LABELLING

PIN	CABLE				DESCRIPTION
	CODE	NO.	COLOUR	ABBRE.	
Power supply	G	1	Red	RD	System neutral
	Y1	6	Purple	VT	Position signal AC 24V/DC 24V - 48V, clockwise
	Y2	7	Orange	OG	Position signal AC 24V/DC 24V - 48V, anti-clockwise

TECHNICAL SPECIFICATION TABLE

AC 24V DC 24V - 48V supply	Operating voltage AC / Frequency Operating voltage DC	AC 24V ±20% / 50/60Hz DC 24V - 48V ±20%
Functional data	Power consumption - Running Power consumption - Holding	AC/DC: 2.3VA / 1.1W AC/DC: 0.5W
	Nominal torque Maximum torque (blocked) Nominal rotary angle / Max. rotary angle Runtime for rotary angle 90° (motor operation)	20Nm 35Nm 90° / 95° ±2° 150s
	Positioning signal	Input voltage Y1 (wire 6) Input voltage Y2 (wire 7) Clockwise Anti-clockwise
	Position indicator	Output signal NA
Auxiliary switches	Not fitted to this model	NA
Connection cables	Cross-section Standard length Permissible length for signal lines	0.75mm ² 0.9m 300m
Degree of protection of housing	As per EN 60529 (note mounting instructions)	IP 54
Environment conditions	Operation / Transport • Temperature • Humidity (non-condensing)	IEC 60721-3-3 / IEC 60721-3-2 -32 +55 °C / -32 +70 °C <95% r.h.
Dimensions	Actuator: W x H x D Damper Shaft: Round / Square Damper Shaft: Min. Shaft length	82mm x 192mm x 60mm 8mm - 20.5mm / 8mm - 14.5mm 20mm
Weight approx.	Without packaging	1.1kg
Service life	Cycles	60 000
Sound level	Motor	<35dB

SAFETY

CAUTION: National safety regulations



- Failure to comply with national safety regulations may result in personal injury and property damage.
- Observe national provisions and comply with the appropriate safety regulations.
 - Use only properly trained technicians for mounting, commissioning and servicing.

INTERNAL DIAGRAM

Open - close / Three position

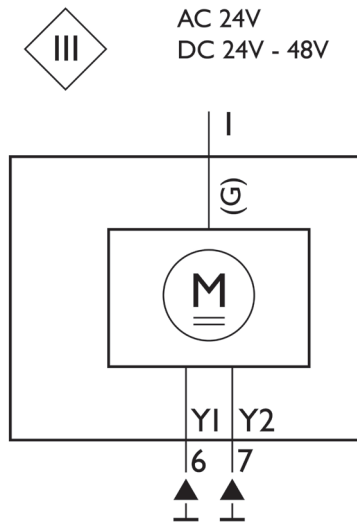

CONNECTION DIAGRAM

**Open - close, single wire control
Single pole single throw (SPST)**

**Open - close, two wire control
Single pole double throw (SPDT)**

Three position control

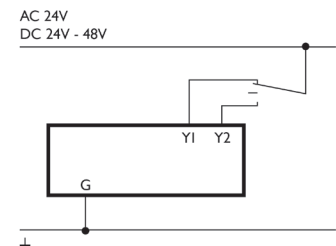
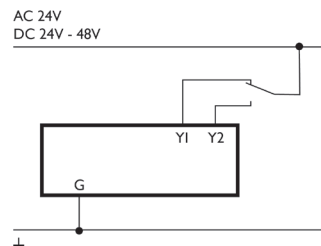
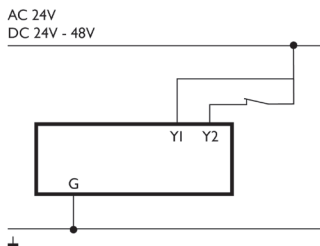
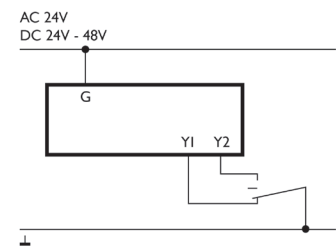
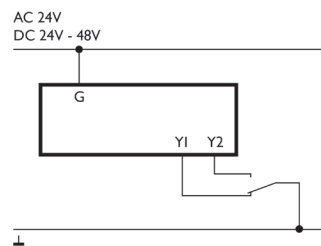
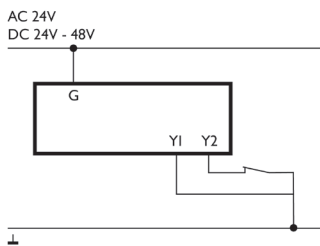

ACTUATOR DIMENSIONS IN MM

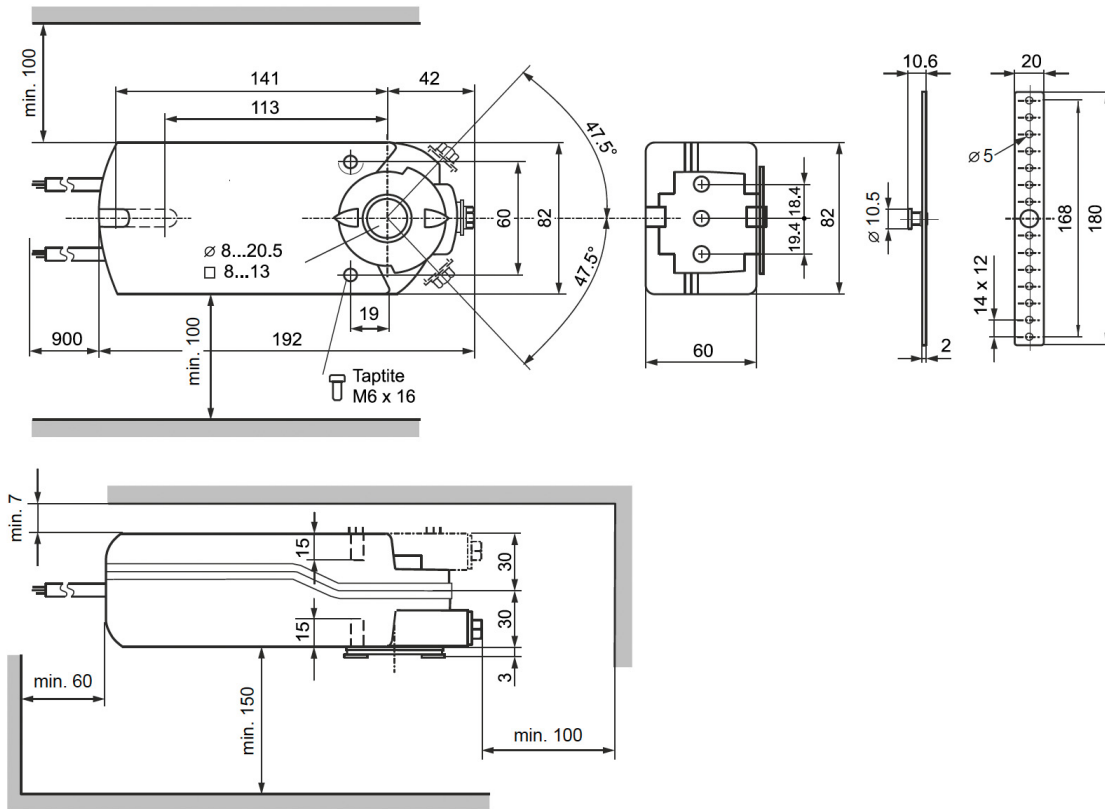

Dimensions in mm